

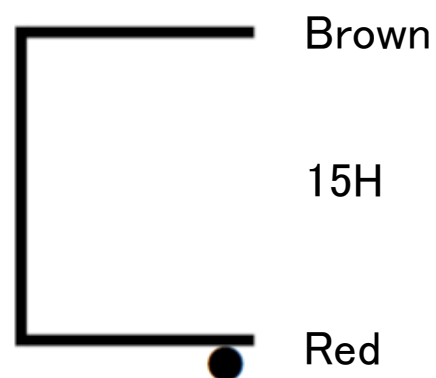

FMC-1524HL  
FINEMET® NANOCRYSTALLINE Core Choke

Audio Feast

### Wiring Connection



Inductance 15H  
Recommended DC current 180mA  
Max DC Current 240mA  
Minimum choke Input current 50mA  
DCR 146 ohm  
Max AC voltage 770V  
Dimension 80x71x120(H)mm  
Black hammered metal case, or Urushi finish

Side screws are not  
in the dimension.

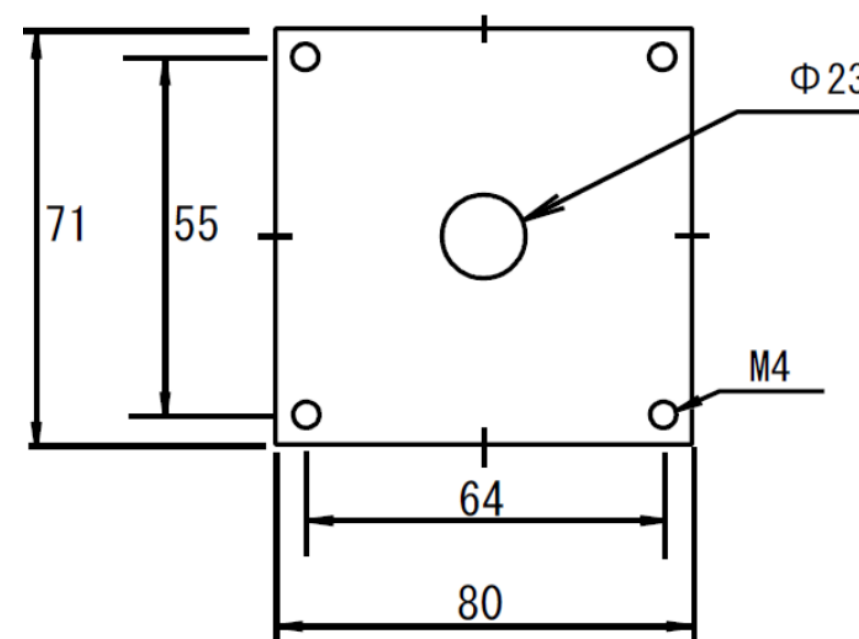
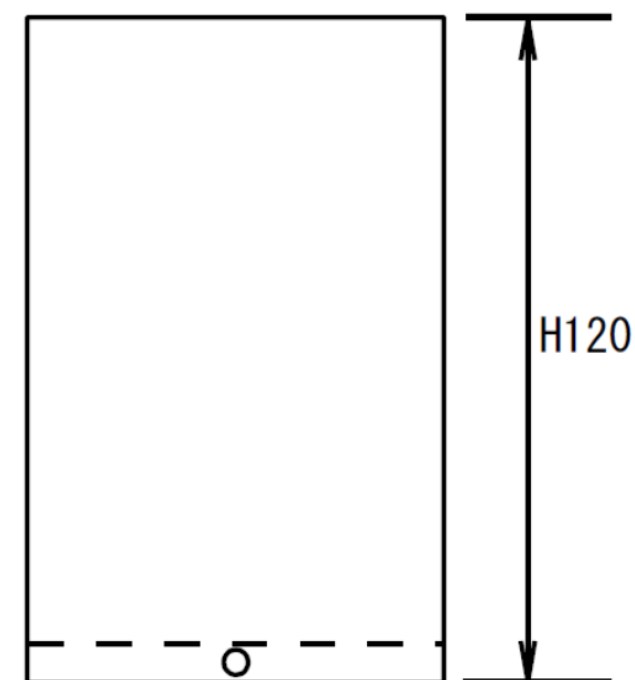

Email: [CleanUnderwear@gmail.com](mailto:CleanUnderwear@gmail.com)

Web: [TheAudioFeast.com](http://TheAudioFeast.com)

Distributed by Audio Feast (Nashville, TN, USA)

Final finish by Teramoto (Myoko, Japan)

Designed by General Ind. (Saitama, Japan)

Oct. 2018